



**Photocoupler**  
**Product Data Sheet**  
LTV-172A

Spec No. :DS70-2019-0237  
Effective Date: 12/10/2019  
Revision: -

**LITE-ON DCC**

**RELEASE**

**BNS-OD-FC001/A4**

## Photocoupler LTV-172A series

### 1. DESCRIPTION

The LITEON LTV-172A consists of an aluminum gallium arsenide infrared emitting diode optically coupled to a photo-MOSFET in a SOP4 package, which is suitable for surface mount assembly. The LTV-172A is suitable for the battery management systems which require space savings.

#### 1.1 Features

- Normally open (1-form-A)
- Operating temperature range: 110°C(max)
- Trigger LED current: 3 mA (max)
- Isolation voltage: 3750 Vrms (min)
- OFF-state output terminal voltage : 60V (min)
- ON-state current : 500mA (max)
- ON-state resistance : 2Ω (max)
- Halogen free option
- Safety standards  
UL1577  
CUL CA5A  
VDE DIN EN60747-5-5 (VDE 0884-5)

#### 1.2 Functional Diagram

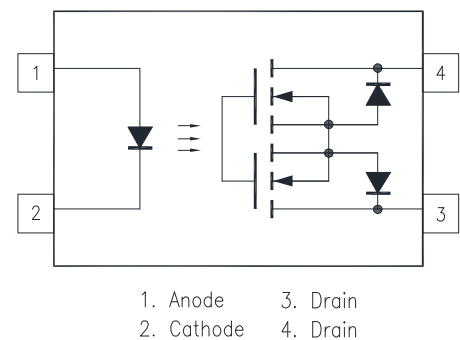

#### 1.3 Applications

- Battery Management System (BMS)
- Factory Automation (FA)
- Security Systems
- Measuring Instruments
- Smart Meters
- Mechanical relay replacements

# Photocoupler LTV-172A series

## 2. PACKAGE DIMENSIONS

### 2.1 LTV-172A series

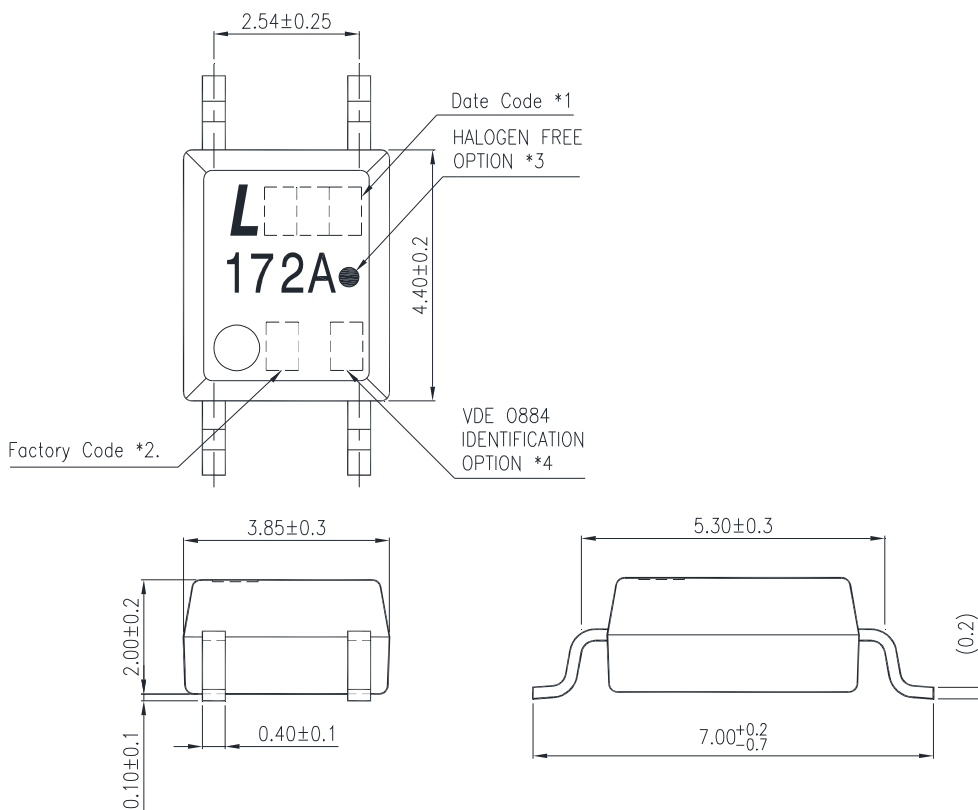

#### Notes:

- 1-digit year code, Example : 2010 = A  
2-digit work week ranging from '01' to '53'
- Factory identification mark shall be marked (W: China -CZ, X: China -TJ)
- "●" indicates halogen free option.
- "4" or "V" for VDE option.

# Photocoupler LTV-172A series

## 3. TAPING DIMENSIONS

### 3.1 LTV-172A-TP

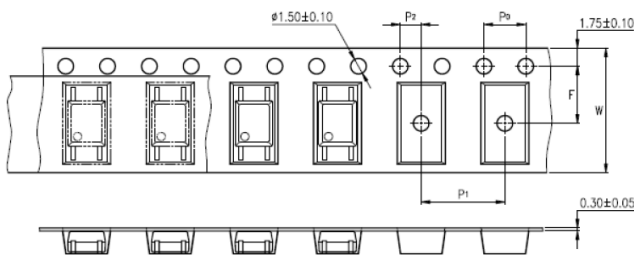

### 3.2 LTV-172A

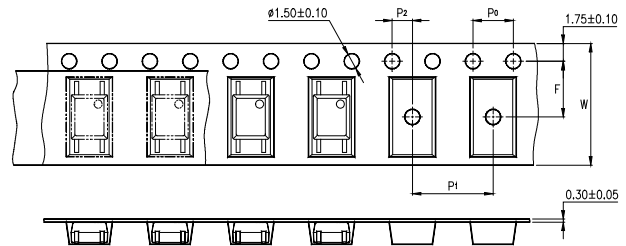

Description	Symbol	Dimension in mm (inch)
Tape wide	W	12±0.3 (0.472)
Pitch of sprocket holes	P <sub>0</sub>	4±0.1 (0.157)
Distance of compartment	F	5.5±0.1 (0.217)
	P <sub>2</sub>	2±0.1 (0.079)
Distance of compartment to compartment	P <sub>1</sub>	8±0.1 (0.315)

### 3.3 Quantities Per Reel

Package Type	LTV-172A Series
Quantities (pcs)	3000

## Photocoupler LTV-172A series

### 4. RATING AND CHARACTERISTICS

#### 4.1 Absolute Maximum Ratings at Ta=25°C

Parameter		Symbol	Rating	Unit
Input	Forward Current	$I_F$	50	mA
	Forward Current Derating ( $T_A \geq 25^\circ\text{C}$ )	$\Delta I_F/^\circ\text{C}$	-0.5	mA/°C
	Peak Forward Current ( 100 $\mu\text{s}$ pulse, 100pps )	$I_{FP}$	1	A
	Reverse Voltage	$V_R$	6	V
	Input Power Dissipation	$P_D$	70	mW
	Junction Temperature	$T_J$	125	°C
Output	OFF-State Output Terminal Voltage	$V_{OFF}$	60	V
	ON-State Current	$I_{ON}$	500	mA
	ON-State Current Derating ( $T_A \geq 25^\circ\text{C}$ )	$\Delta I_{ON}/^\circ\text{C}$	-4.95	mA/°C
	ON-State Current (pulsed) ( $t=100\text{ms}$ , Duty=1/10 )	$I_{ONP}$	1.5	A
	Output Power dissipation	$P_O$	300	mW
Isolation Voltage (Note 1.)	$V_{iso}$	3750	V	
Operating Temperature	$T_{opr}$	-40 ~ +110	°C	
Storage Temperature	$T_{stg}$	-55 ~ +125	°C	
Soldering Temperature	$T_{sol}$	260 (For 10 seconds)	°C	

#### 4.2 RECOMMENDED OPERATING CONDITIONS (Note)

Characteristics	Symbol	Min.	Typ.	Max.	Unit
Supply Voltage	$V_{DD}$	-	-	48	V
Forward Current	$I_F$	5	7.5	25	mA
On-state Current	$I_{ON}$	-	-	500	
Operating Temperature	$T_{opr}$	-20	-	100	°C

Note : The recommended operating conditions are given as a design guide necessary to obtain the intended performance of the device. Each parameter is an independent value. When creating a system design using this device, the electrical characteristics specified in this datasheet should also be considered.

#### 4.3 ELECTRICAL OPTICAL CHARACTERISTICS at Ta=25°C

Note :

## Photocoupler LTV-172A series

1. AC For 1 Minute, R.H. = 40 ~ 60%. Isolation voltage shall be measured using the following method.

- (1) Short between anode and cathode on the primary side and between collector and emitter on the secondary side.
- (2) The isolation voltage tester with zero-cross circuit shall be used.
- (3) The waveform of applied voltage shall be a sine wave.

2. Turn on / turn off time

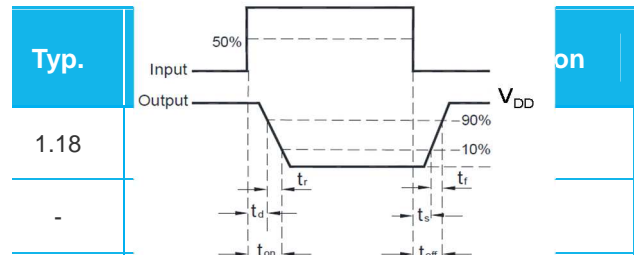

Output	OFF-State Current	$I_{OFF}$	-	-	-	$\mu A$	$V_{OFF}=00V$
	Trigger LED Current	$I_{FT}$	-	0.8	3	mA	$I_{ON}=500mA$
Coupled	Return LED Current	$I_{FC}$	0.1	0.6	-	mA	$I_{OFF}=100\mu A$
	On Resistance	$R_{on}$	-	1	2	$\Omega$	$I_F=5mA, I_{ON}=500mA$
Transfer characteristics	Turn on time (Note 2.)	$T_{on}$	-	0.2	2	ms	$R_L=200\Omega, V_{DD}=20V$ $I_F=5mA$
	Turn off time (Note 2.)	$T_{off}$	-	0.1	0.5	ms	
	Isolation Resistance	$R_{iso}$	$5 \times 10^{10}$	-	-	$\Omega$	DC500V, R.H.40 ~ 60%

## 5. CHARACTERISTICS CURVES

## Photocoupler LTV-172A series

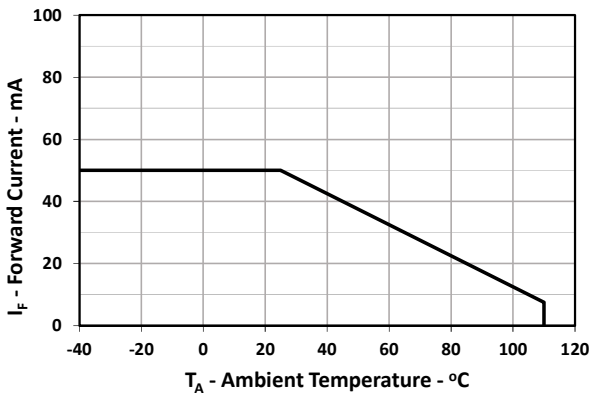

Fig. 1-1 Forward Current vs. Ambient Temperature

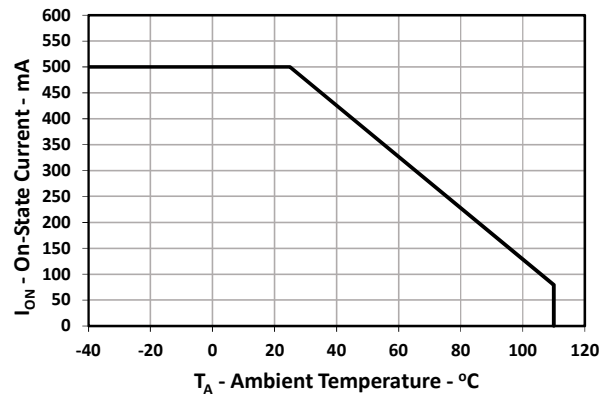

Fig. 1-2 On-State Current vs. Ambient Temperature

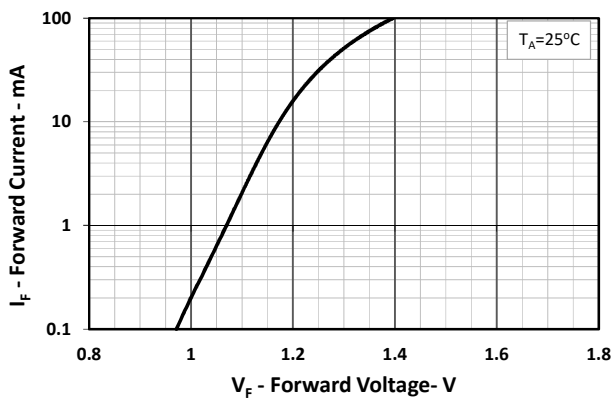

Fig. 2 Forward Current vs. Forward Voltage

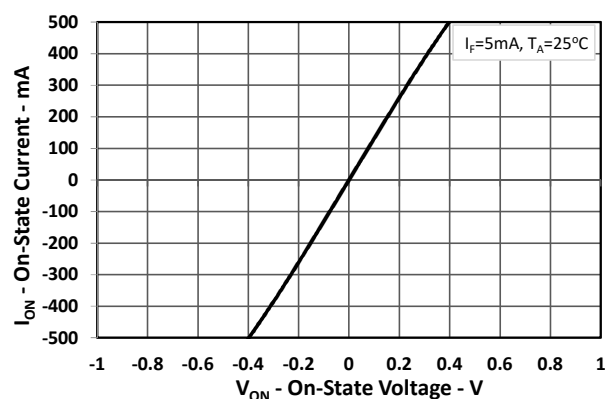

Fig. 3 On-State Current vs. On-State Voltage

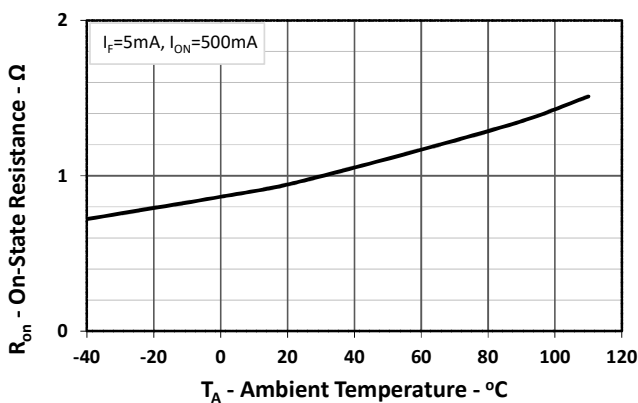

Fig. 4 On-State Resistance vs. Ambient Temperature

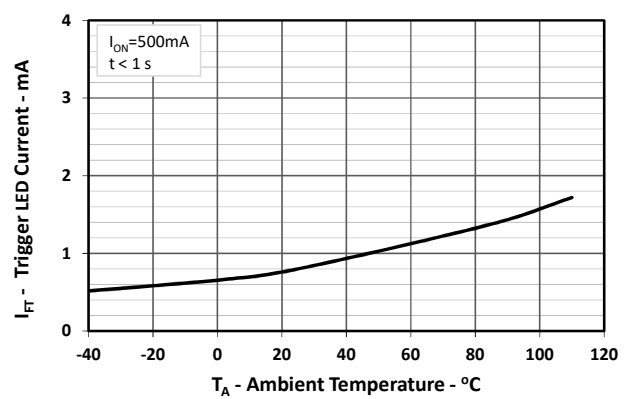

Fig. 5 Trigger LED Current vs. Ambient Temperature

## Photocoupler LTV-172A series

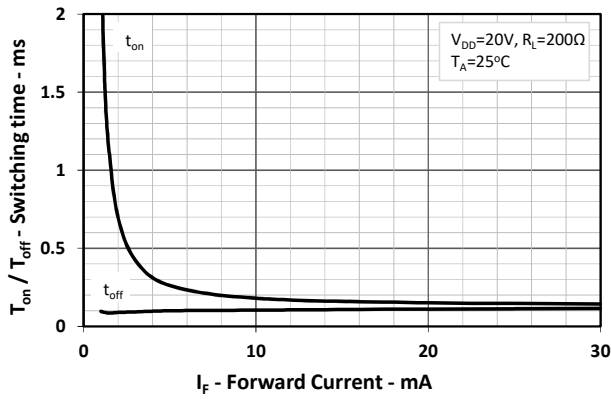

Fig. 6 Switching time vs. Forward Current

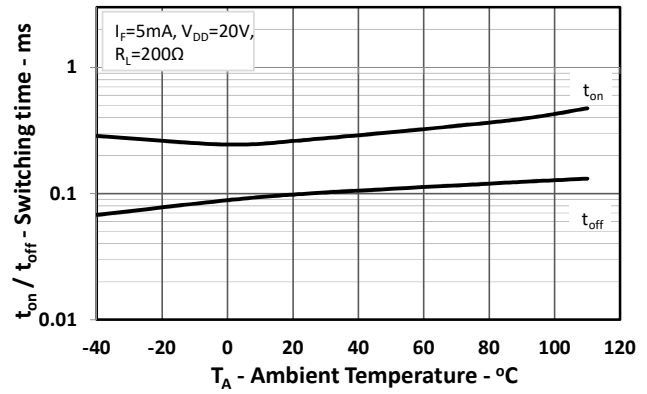

Fig. 7 Switching time vs. Ambient Temperature

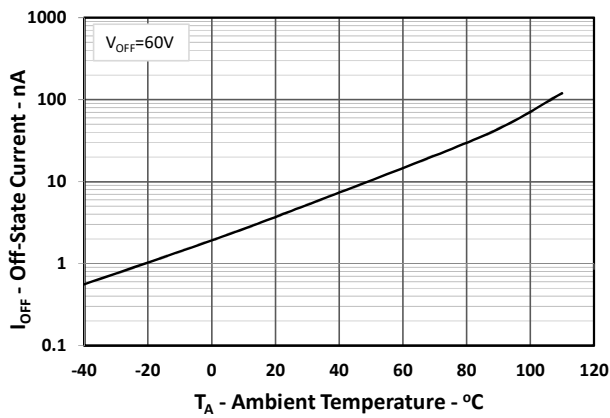

Fig. 8 Off-State Current vs. Ambient Temperature



# Photocoupler LTV-172A series

## 6. TEMPERATURE PROFILE OF SOLDERING

### 6.1 IR Reflow soldering (JEDEC-STD-020E compliant)

One time soldering reflow is recommended within the condition of temperature and time profile shown below. Do not solder more than twice

Profile item	Conditions
Preheat	
- Temperature Min ( $T_{Smin}$ )	150°C
- Temperature Max ( $T_{Smax}$ )	200°C
- Time (min to max) (ts)	90±30 sec
Soldering zone	
- Temperature ( $T_L$ )	217°C
- Time ( $t_L$ )	60 sec
Peak Temperature ( $T_P$ )	260°C
Ramp-up rate	3°C / sec max.
Ramp-down rate	3~6°C / sec

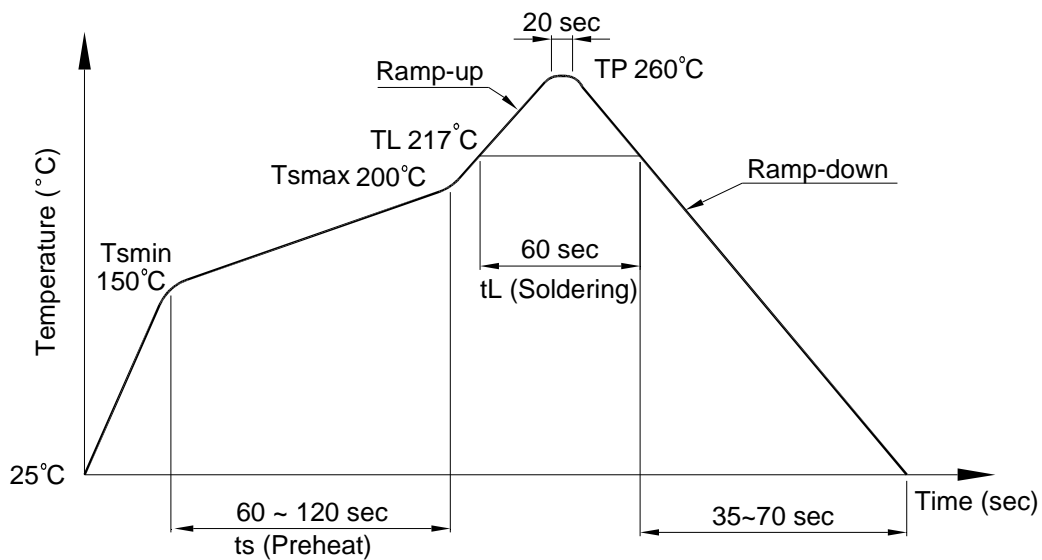

# Photocoupler LTV-172A series

## 6.2 Wave soldering (JEDEC22A111 compliant)

One time soldering is recommended within the condition of temperature.

Temperature:  $260 \pm 0 / -5^{\circ}\text{C}$

Time: 10 sec.

Preheat temperature: 25 to  $140^{\circ}\text{C}$

Preheat time: 30 to 80 sec.

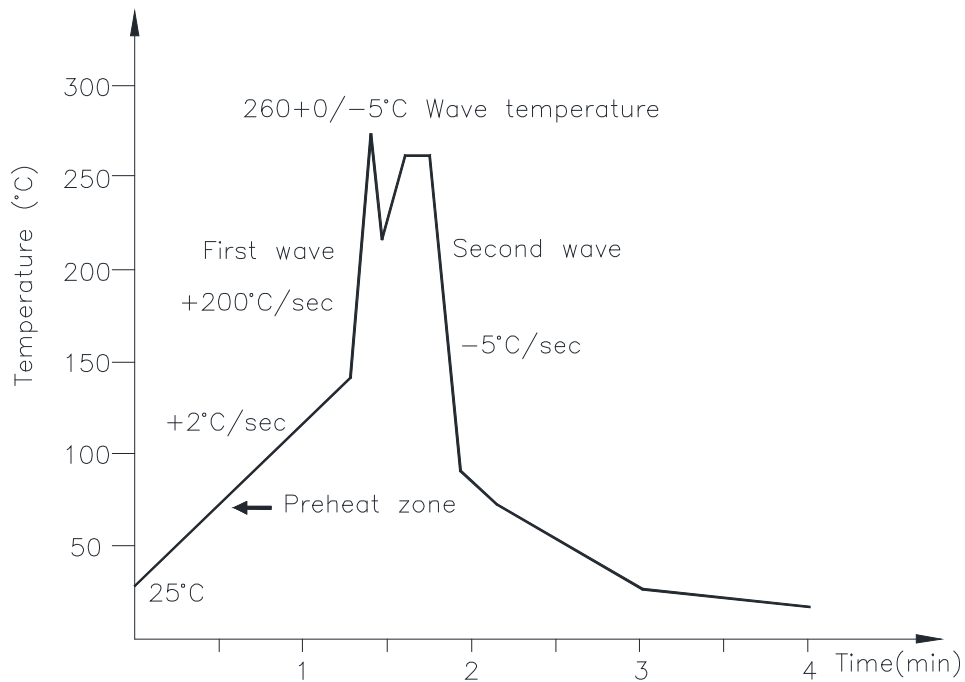

## 6.3 Hand soldering by soldering iron

Allow single lead soldering in every single process. One time soldering is recommended.

Temperature:  $380 \pm 0 / -5^{\circ}\text{C}$

Time: 3 sec max.

**Photocoupler  
LTV-172A series**

**7. NAMING RULE**

**LTV-172A-(1)-G**

DEVICE PART NUMBER

(1) TAPING TYPE (TP, no suffix)

LTV-172A has tape and reel solution.

Please refer to orientation of taping on P.3

(2) Halogen free option

Example : LTV-172A-TP-G

**LTV172A(1)-V-G**

DEVICE PART NUMBER

(1) TAPING TYPE (TP, no suffix)

LTV-172A has tape and reel solution.

Please refer to orientation of taping on P.3

(2) VDE option

(3) Halogen free option

Example : LTV172ATP-V-G

**8. NOTES**

- LiteOn is continually improving the quality, reliability, function or design and LiteOn reserves the right to make changes without further notices.
- The products shown in this publication are designed for the general use in electronic applications such as office automation equipment, communications devices, audio/visual equipment, electrical application and instrumentation.
- For equipment/devices where high reliability or safety is required, such as space applications, nuclear power control equipment, medical equipment, etc, please contact our sales representatives.
- When requiring a device for any "specific" application, please contact our sales in advice.
- If there are any questions about the contents of this publication, please contact us at your convenience.
- The contents described herein are subject to change without prior notice.
- Immerge unit's body in solder paste is not recommended.